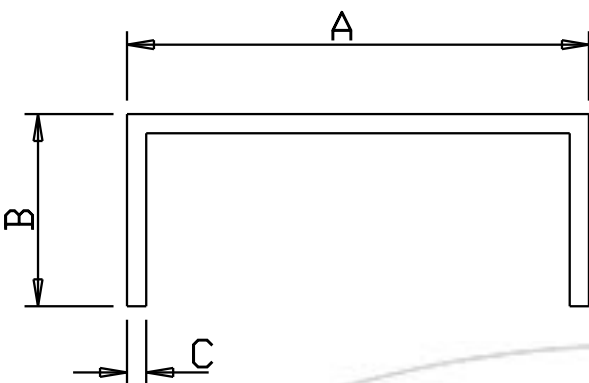
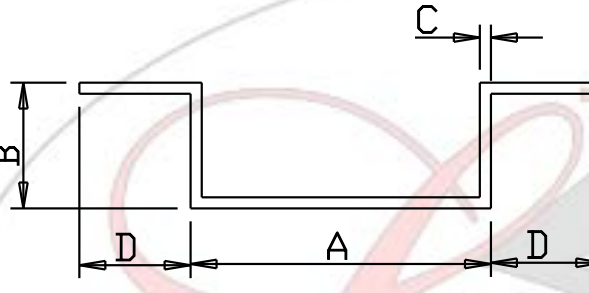
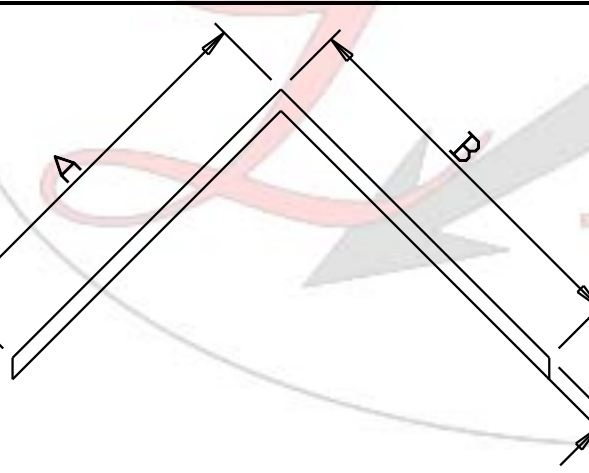

Polyester glass pressed sections and corners

Section (mm)	Type	A (mm)	B (mm)	C (mm)	D (mm)	Length (mm)	Length (mm)
	01	120	50	5	-	500	-
	02	218	40	4	-	400	-
	03	170	40	4	-	1150	-
	04	83	40	5	-	1150	-
	05	50	40	5	-	600	-
	06	60	40	5	-	600	-
	08	100	75	20	-	1080	-
	07	83	40	3	40	1100	-
	09	81	34	3	30	500	-
	11	100	100	3	-	1100	1540
	12	100	100	4	-	1100	1540
	13	100	100	5	-	1100	1540
	14	100	100	6	-	1100	1540
	15	100	100	8	-	1100	1540
	16	100	100	10	-	1100	1540
	17	100	100	15	-	1100	1540
	18	100	100	20	-	1100	1540

Colour: Red. White available on demand.

TO BE KEPT in dry stores.

We are available to effect cutting to measurement as well as machining to drawing of parts by CNC.

Polyester glass pressed sections and corners

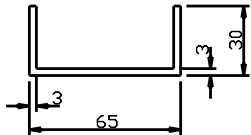
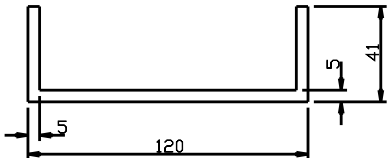
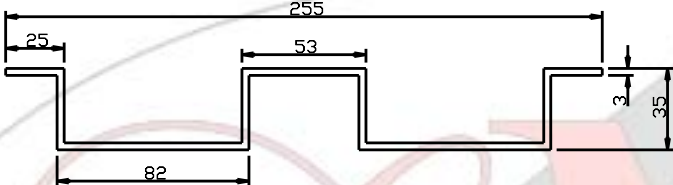
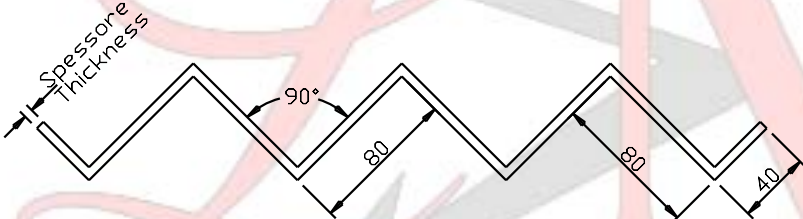
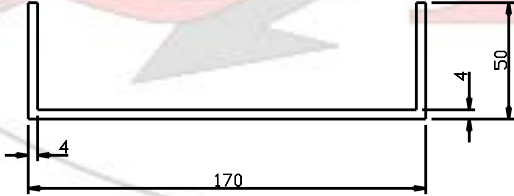
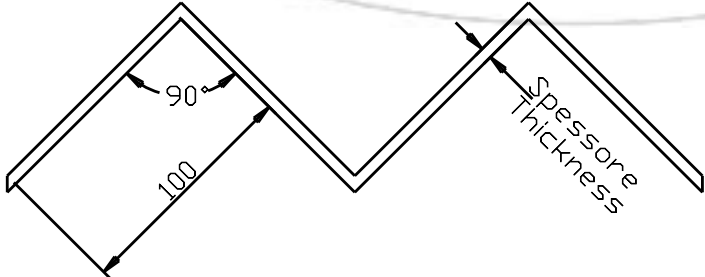
Type	Section (mm)	Sp. (mm)	Height (mm)	Internal radius (mm)	External radius (mm)
A		3	1100	1,5	2,5
B		5	1100	1,5	2
C		3	1100	1,5	3
D		3 4 5 8 10	1100	1,5	4 - 4,5
G		4	1100	5,5 - 6	8
H		3 4 6 8 10	1100	0,5 - 1	Right angle

TO BE KEPT in dry stores.

We are available to effect cutting to measurement as well as machining to drawing of parts by CNC.

Polyester glass pressed corners

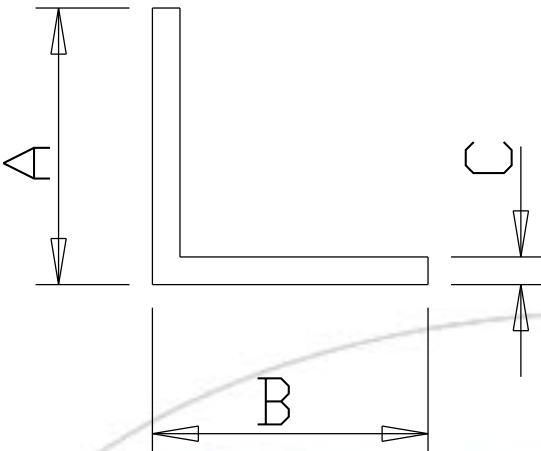
Section (mm)	A (mm)	B (mm)	C (mm)	Length (mm)	Std. Package (pieces per package)
	15	15	2	2000	25
	25	15	2	2000	25
	25	25	3	6000	
	30	30	3	2000 6000	
	50	50	3	2000	
	60	60	3	2000 6000	

Colour: Red RAL 3020.

TO BE KEPT in dry stores.

We are available to effect cutting to measurement as well as machining to drawing of parts by CNC.